

2



Section at Station  
2



Keel Notch

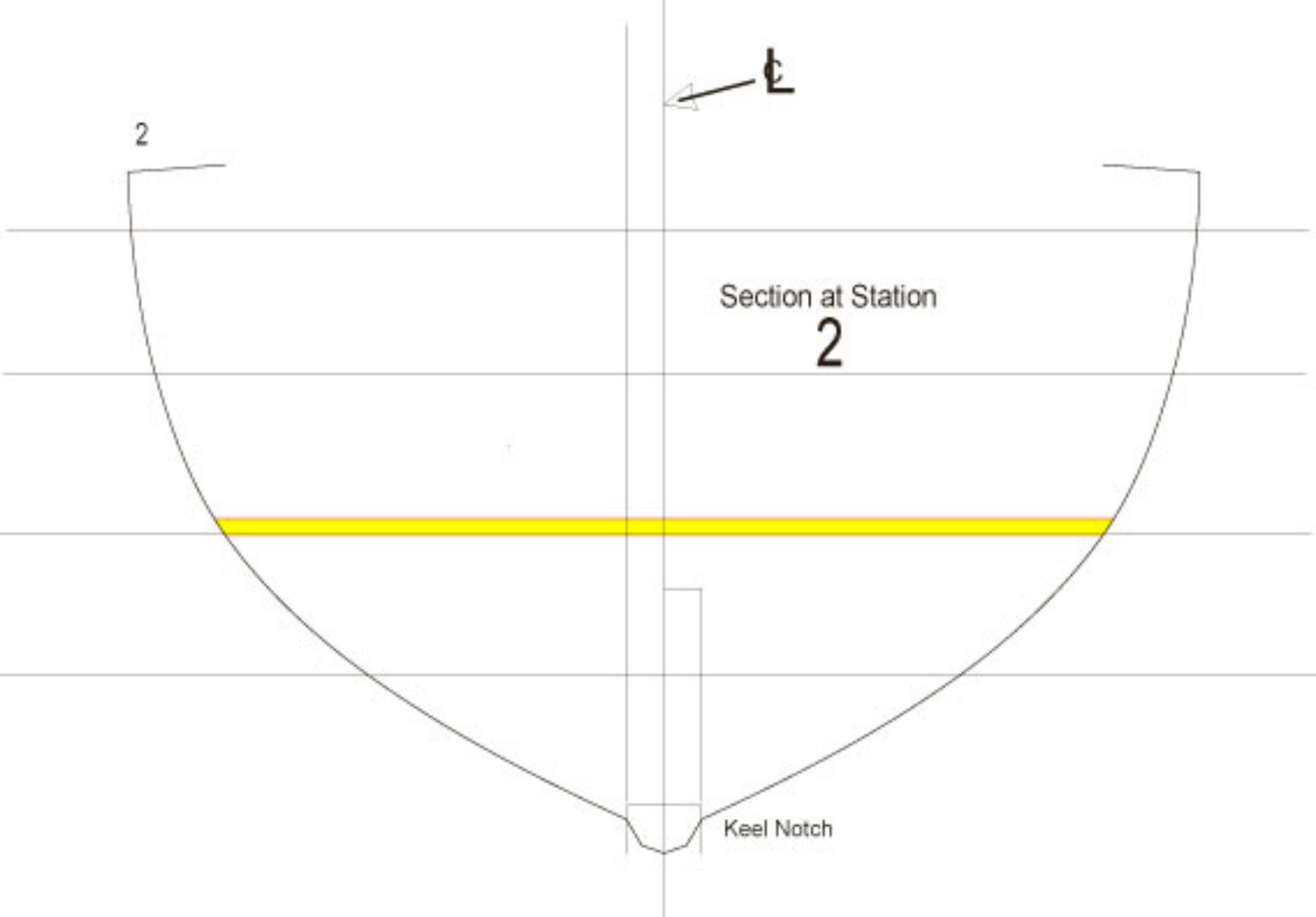

3



Section at Station

3

Keel Notch

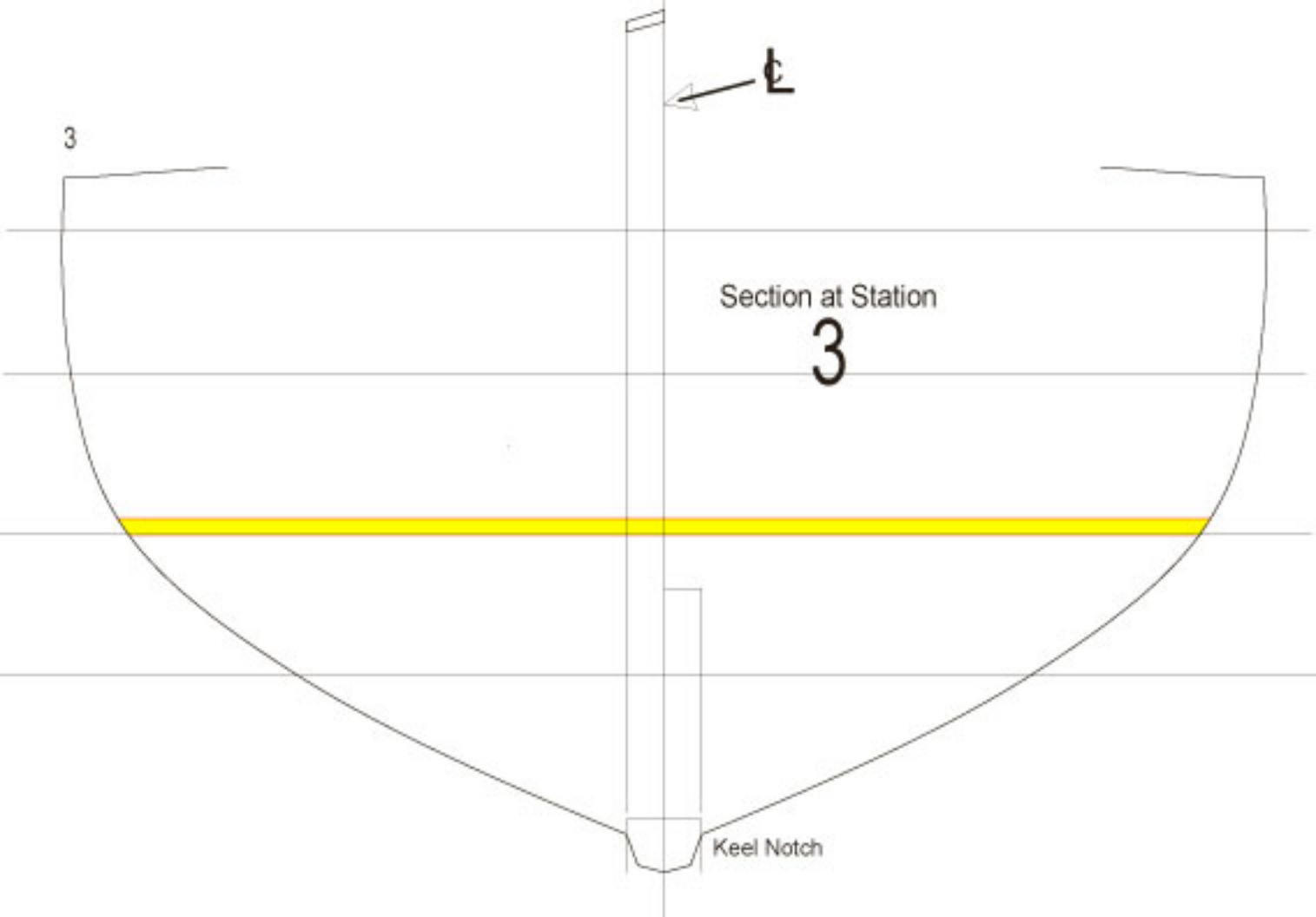

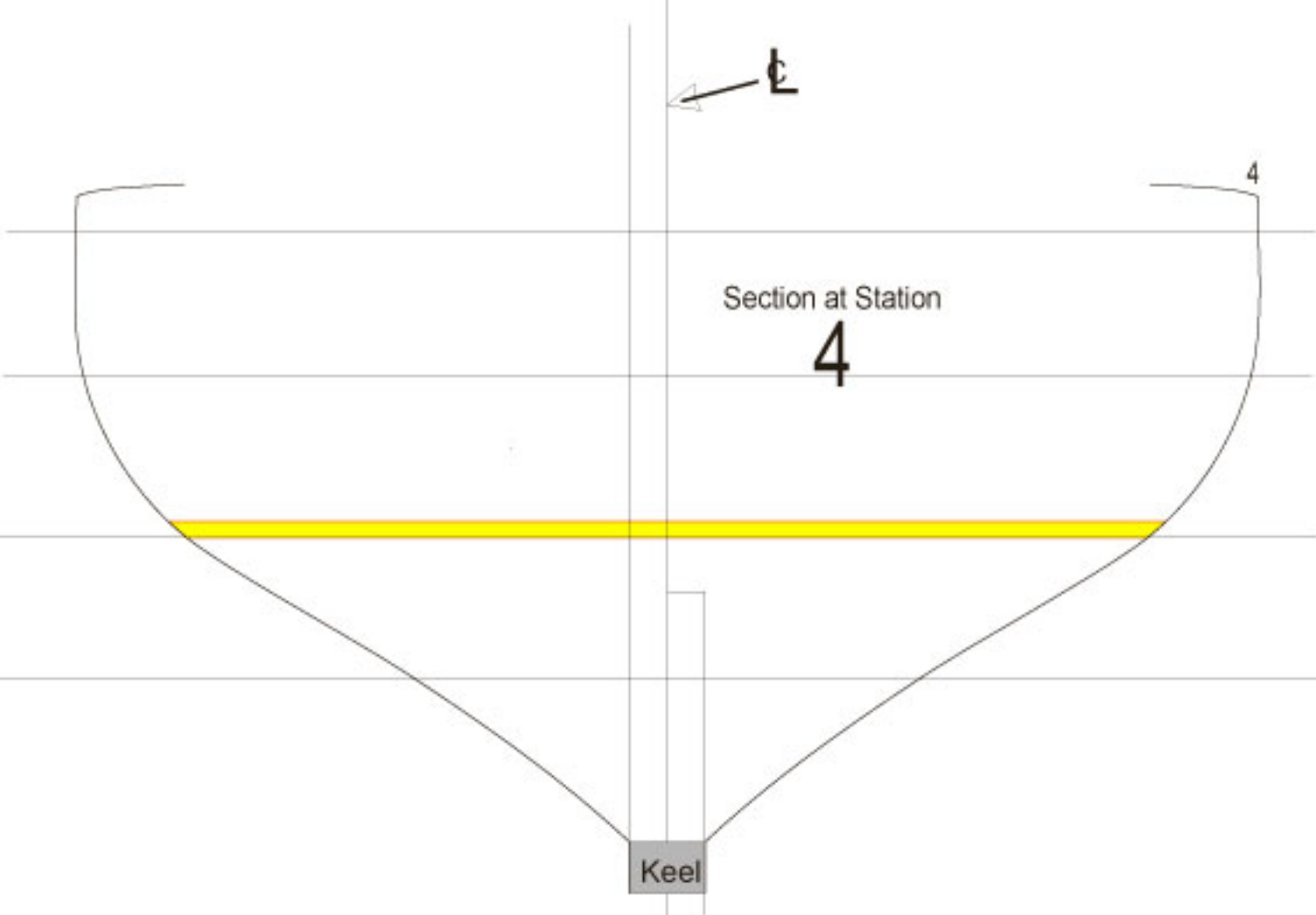

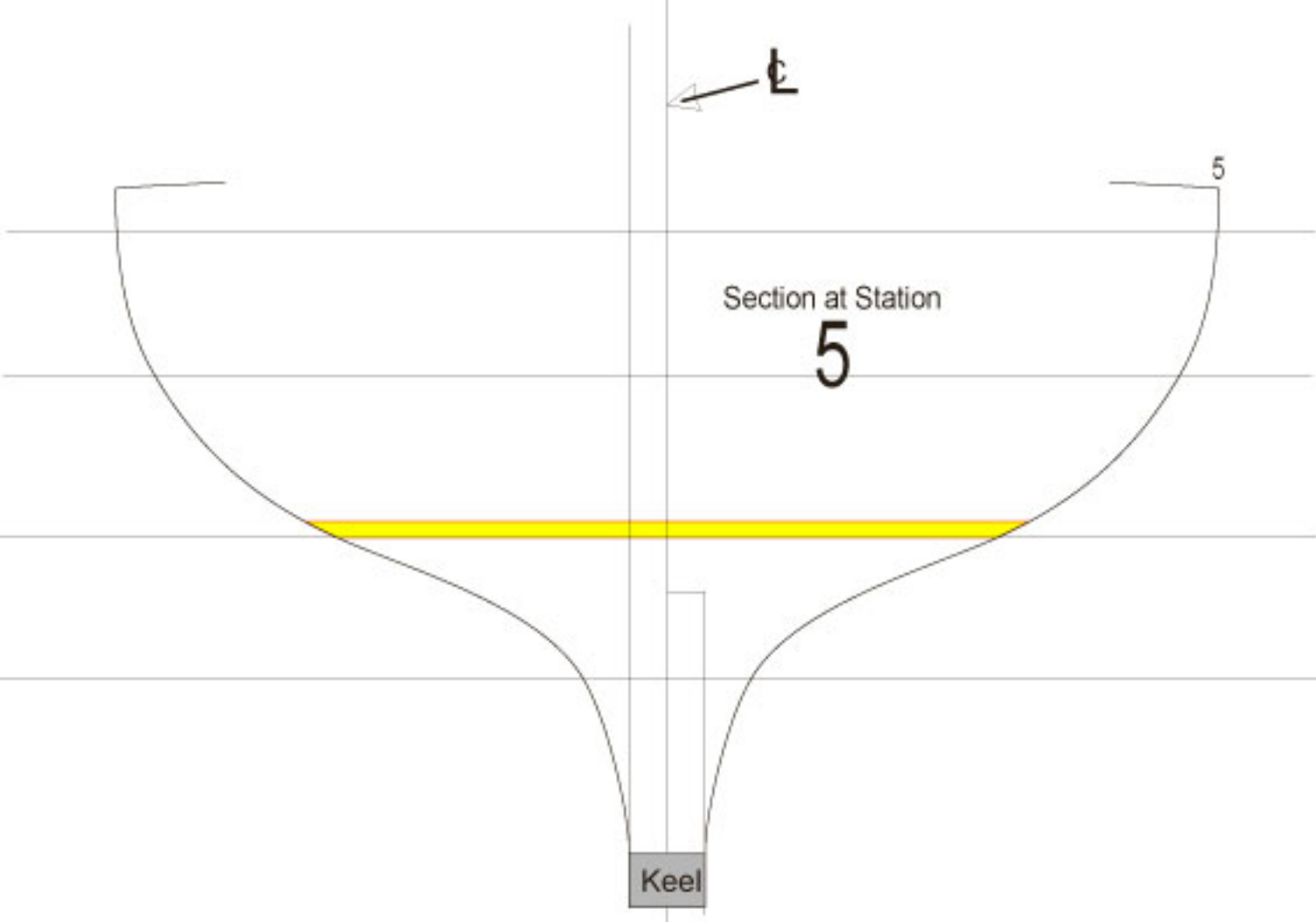

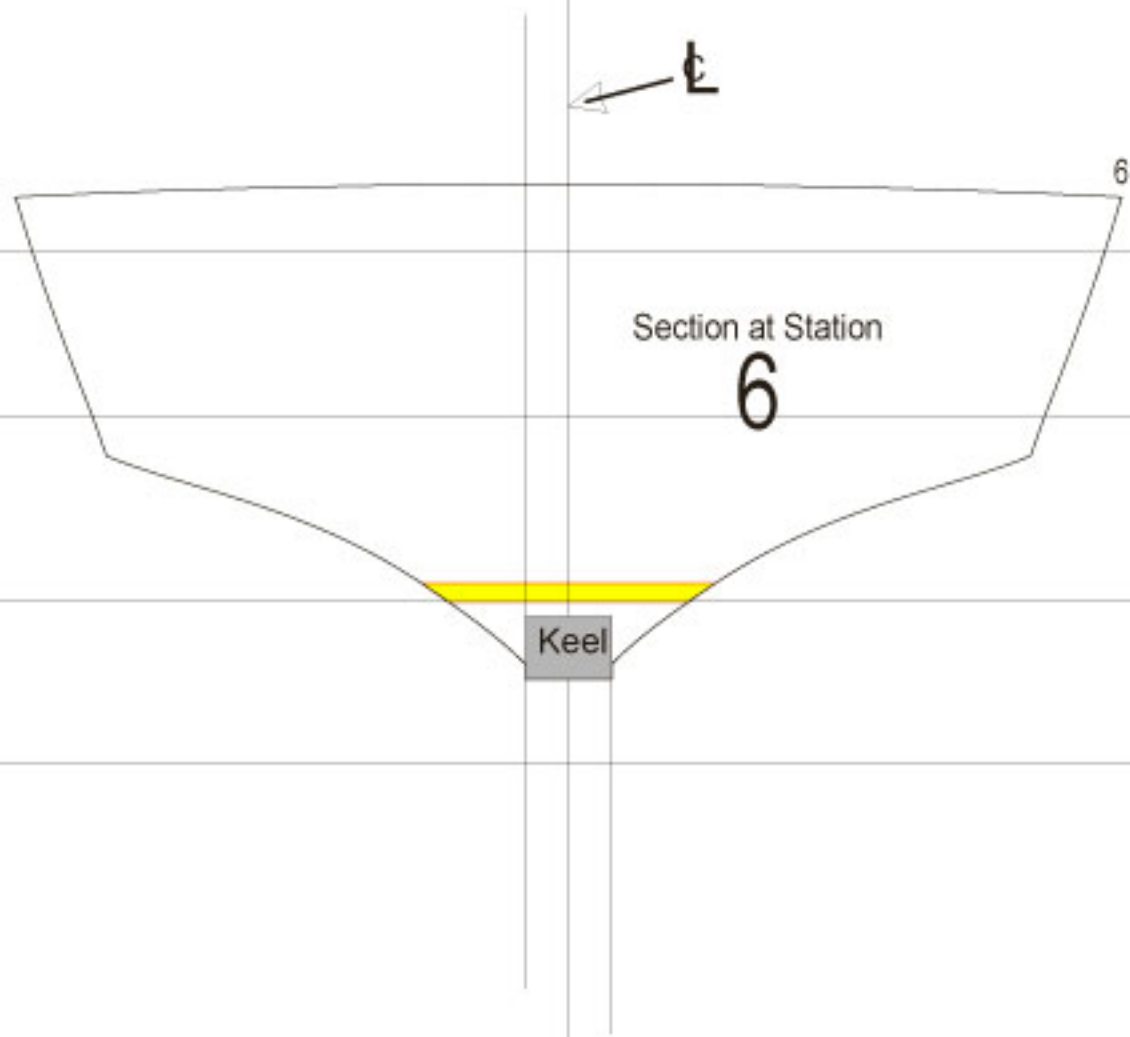

Reference Rule 30' Long (1 inch Division)

Reference Rule 17' Long

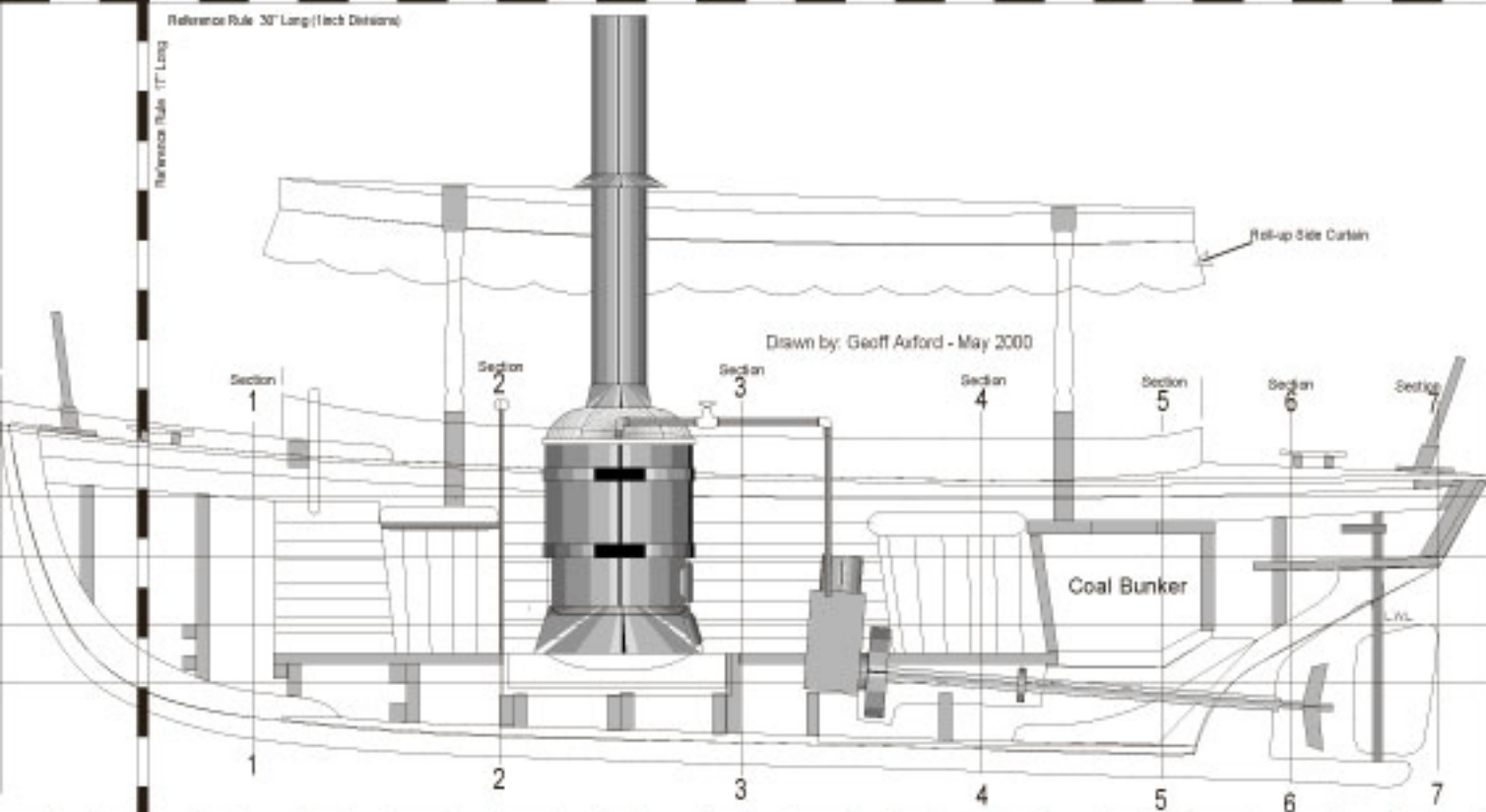

# All Sections

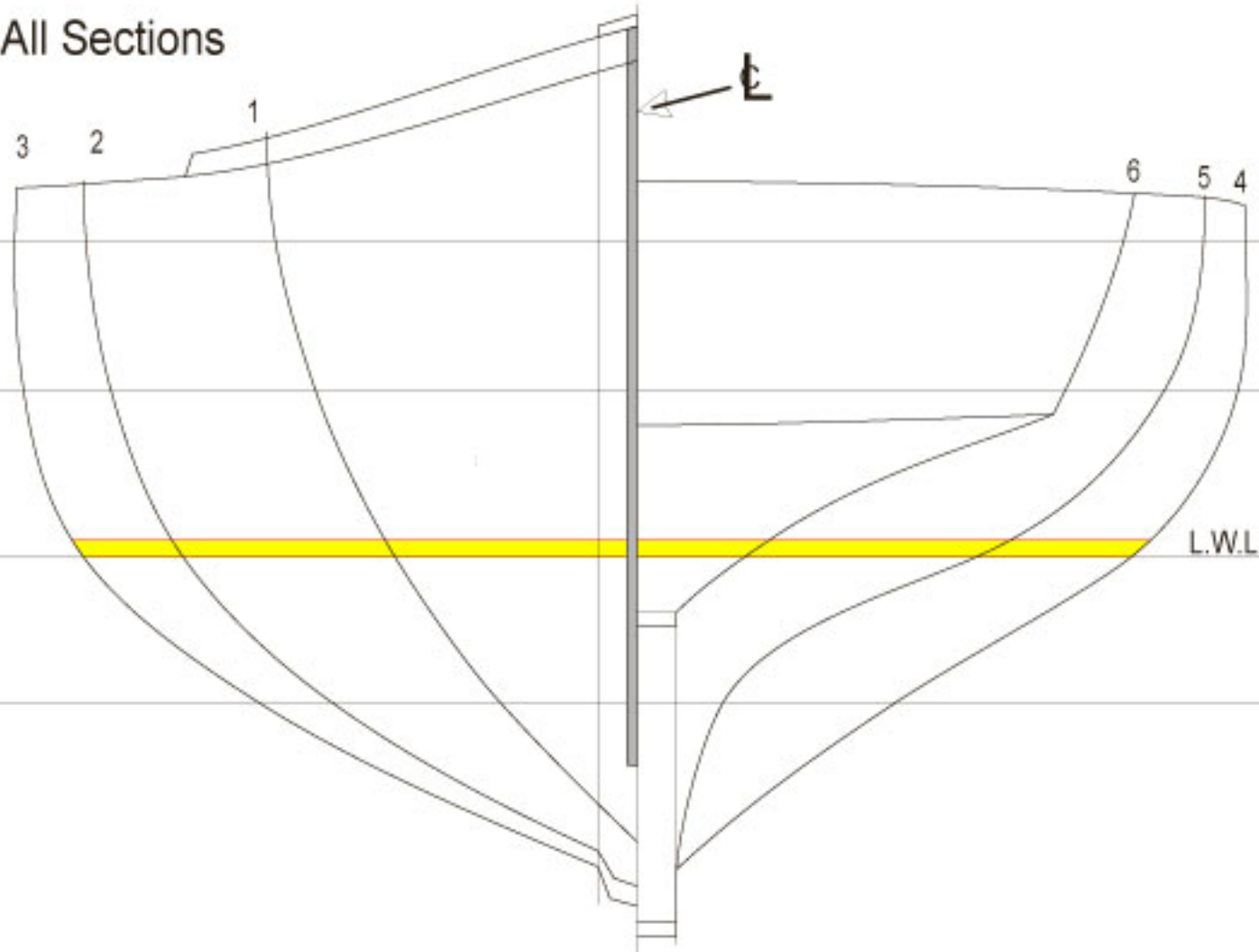

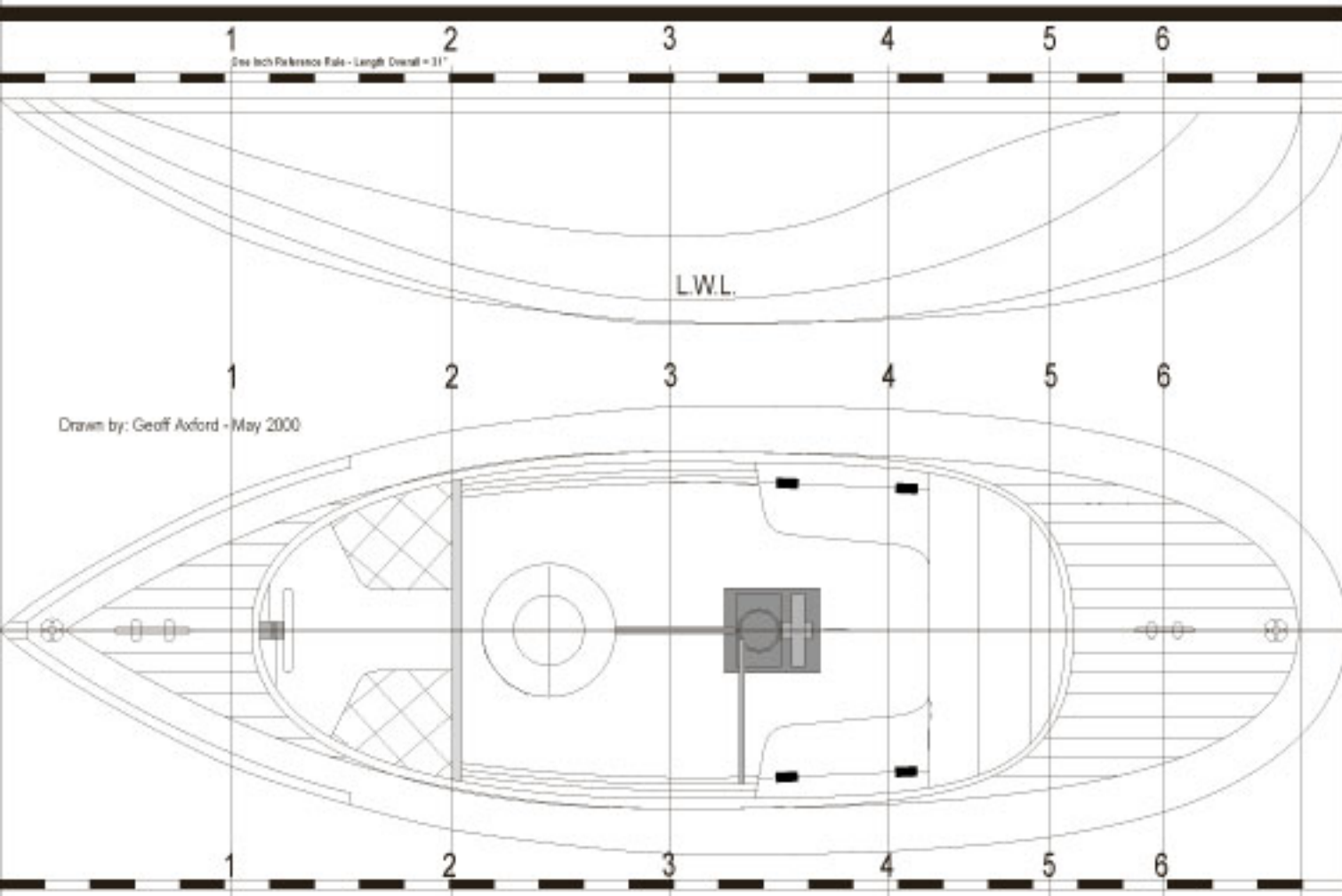

# All Sections

